

ZW-6 series

HITACHI

Reliable Solutions

**ZW330**



## WHEEL LOADER

Model code : ZW330-6

Engine output : 232 kW / 311 hp (ISO14386)

Operating weight : 26 500 – 27 100 kg

Bucket ISO heaped : 3.9 – 5.0 m<sup>3</sup>

# ZW330-6. NO COMPROMISE

Exceptionally durable and reliable, the ZW330-6 is ideal for working in tough conditions. Designed and built using pioneering technology, it incorporates high-quality and robust components that can withstand the challenges of busy job sites.

Thanks to low levels of fuel consumption and greater traction force, the new ZW-6 wheel loader can deliver high levels of performance without compromising on efficiency.



6. COMPLETE RELIABILITY



8. BUILT FOR DURABILITY



10. OUTSTANDING VERSATILITY



**12. THE HIGHEST QUALITY**



**14. DRIVEN BY TECHNOLOGY**

# DEMAND PERFECTION

Hitachi has developed the ZW330-6 to perfection, using unique technology and a focus on durability, operator comfort and safety. Robust materials and strengthened components ensure a reliable performance. It is designed and built to deliver exceptional productivity at the lowest possible cost of ownership.



**Powerful performance**  
Quick power switch increases engine output when required.



**Industry-leading safety**  
360° visibility from the cab.



**Increased productivity**  
The lift arm raises quicker than ZW-5 model.



**Easy loading operation**  
26% improved traction force for easier loading.



**Easy to operate**  
Multifunctional monitor shows information at a glance.



**Smooth operation**  
Ride control minimises machine pitching.



**Superior comfort**  
Spacious cab with several storage compartments.





**Enhanced design**

Excellent rear view thanks to the curved engine hood.



**Low emissions**

SCR system without DPF reduces NO<sub>x</sub> from exhaust gas.



**Reduced running costs**

7% fuel saving in V-shaped loading.



**Excellent visibility**

LED rear conventional lights.



**User-friendly**

Effortless control with the optional Joystick Steering System.



**Convenient access**

Easy-to-open wide engine covers.



**Improved fuel efficiency**

Lock-up transmission and Stage IV-compliant engine.

# COMPLETE RELIABILITY

Built using decades of experience in manufacturing reliable construction machinery, the ZW330-6 has been developed by Hitachi to perform efficiently. Its design includes several easy maintenance features to ensure minimal downtime and high levels of availability.

## Quick access

The engine covers open fully for the convenience of technical support. The urea tank is also located for safe and easy access from ground level. These help to ensure routine maintenance is completed quickly to ensure a reliable performance.

## Improved fuel efficiency

The lock-up transmission has improved the fuel efficiency of the ZW330-6 while travelling, which reduces running costs.

## Easy maintenance

For safer and easier maintenance, the battery disconnect switch is now included as standard. This helps to avoid electrical

accidents and retain battery energy during long-term storage.

## Reduced costs

The new Stage IV-compliant engine does not require a diesel particulate filter, which further reduces fuel consumption and maintenance costs.

## Reliable performance

The lift arm contributes to the reliable performance of the ZW330-6. Its speed has been improved and it stops smoothly thanks to the flow control system for increased productivity. It is easy to control using the auto leveller.



Easy access to the engine compartment.



The battery is easy to maintain.



New engine reduces fuel consumption.



New rear grille protects radiator compartment.



Durable radiators are corrosion resistant.





**i** Hitachi wheel loaders are tested extensively in job site conditions around the world, in extreme temperatures.



# BUILT FOR DURABILITY

Ultimate durability is required from Hitachi ZW-6 wheel loaders. The ZW330-6 is equipped with reinforced parts, strengthened components and robust features to ensure it meets the needs of customers working in demanding conditions. It has been designed and engineered to withstand the toughest environments.



### Increased protection

The newly designed rear grille prevents raw material from the job site entering the radiator compartment. This provides greater protection for this durable component.

### Robust design

The lift arm, front and rear frame of the ZW330-6 have been designed to be able to handle the rigours of heavy applications.

### Durable materials

High-quality radiators improve resistance to corrosion and enhance the overall durability of the ZW330-6 wheel loader.

### Efficient cooling

The reversible cooling fan, activated manually or automatically every 30 minutes, ensures that the radiator stays clean during operation.



The optional belly guard provides added protection.

# OUTSTANDING VERSATILITY

The versatility of the ZW330-6 is enhanced by its smooth operation and user-friendly features. It demonstrates speed and precision on a wide range of applications, and the all-round visibility from the cab ensures industry-leading safety for a variety of busy job sites.

## Enhanced rear visibility

The muffler and air intake have been moved further away from the cab to improve visibility through the rear window.

## Greater traction force

The traction force has improved by 26% compared to the previous model. The result is a more efficient loading operation.

## Efficient flexibility

The quick power switch increases engine output when more power is instantly required, or when driving uphill.

## Effective control

To ensure a smooth drive on all kinds of terrain, the ride control feature prevents unnecessary pitching via the movement of lift arm cylinders.

## High productivity

The simultaneous movement of the bucket and lift arm ensures a smooth digging operation. The bucket is prioritised after unloading so that the wheel loader quickly returns to digging, which helps to increase productivity.



Rear visibility has been enhanced by design modifications.



The ride control feature ensures a smooth performance.



The quick power switch increases power when required.



The comfortable cab offers excellent all-round visibility of the job site.



LED work lights enhance visibility in low light conditions.



**i** The final checking and inspection procedure for each Hitachi wheel loader is typical of Hitachi's dedication to manufacturing products of unfailing quality in response to customer needs.



# THE HIGHEST QUALITY

The inherent quality of a Hitachi ZW-6 wheel loader is one of the reasons why it remains at the forefront of the industry in terms of comfort and safety. With first-rate design elements and superior components, it also offers exceptional visibility from the cab and a low-noise performance that ensures it's one of the quietest on the market.



The optional Joystick Steering System provides exceptional control.

## Reduced emissions

A selective catalytic reduction (SCR) system injects urea into exhaust gas to reduce nitrogen oxide from emissions. This cutting-edge technology not only helps the environment, but also complies with EU Stage IV emission regulations.

## Increased safety

To enhance visibility in low light conditions, the ZW330-6 is fitted with LED tail lights and optional LED work lights at the front and rear.

## Excellent visibility

The 360° panoramic view of the spacious cab creates a comfortable working environment, and helps to increase safety

and productivity. The rear-view camera, in combination with the unique two-piece counterweight, also contributes to excellent all-round visibility and safety on the job site.

## Low-noise performance

To significantly reduce noise levels in the cab, sound insulation has been improved. As a result of this and the low-noise engine, operators can enjoy a quieter working environment.

## User-friendly operation

The optional Joystick Steering System enables operators to reach high levels of productivity with effortless steering, and incorporates a number of useful functions.

# DRIVEN BY TECHNOLOGY

Unique technology is at the heart of the design of Hitachi ZW-6 wheel loaders. As a result, they are state-of-the-art machines that incorporate the most advanced features and components. They are engineered to satisfy the demands of the European construction industry for equipment that not only offers high productivity, but also the lowest possible cost of ownership.

## **Reduced maintenance**

A new Stage IV-compliant engine contains a high-volume cooled exhaust gas recirculation (EGR) system, a common rail-type fuel injection system and a diesel oxidation catalyst (DOC) without DPF. This helps to reduce fuel costs and maintenance requirements.

## **Smaller environmental impact**

The optional auto shutdown feature helps to prevent fuel wastage, as well as reduce noise levels, exhaust emissions and NOx levels of the ZW330-6 wheel loader.

## **Optimum performance**

Hitachi ZW-6 wheel loaders are fitted with a multifunctional LCD colour monitor that shows useful information at a glance, such as fuel and urea levels, oil temperature and power modes. It ensures an optimum performance and easy maintenance. It also includes the display for the easy-to-use rear-view camera, which enhances visibility for a safe operation.

## **Remote monitoring**

Global e-Service allows ZW330-6 owners to monitor their Hitachi machines remotely via Owner's Site (24/7 online access) and ConSite (an automatic monthly report). These help to maximise efficiency, minimise downtime and improve overall performance.



The LCD monitor shows the machine's status and settings.



Covers open fully to give easy access for maintenance.



Remote monitoring with Global e-Service helps to maximise efficiency.

# REDUCING THE TOTAL COST OF OWNERSHIP



Hitachi has created the Support Chain after-sales programme to ensure optimum efficiency, as well as minimal downtime, reduced running costs and high resale values.

## Global e-Service

Hitachi has developed two remote monitoring systems as part of its Global e-Service online application. Owner's Site and ConSite are an integral part of the wheel loader, which sends operational data daily via GMS to [www.globaleservice.com](http://www.globaleservice.com). This allows immediate access to the Owner's Site, and the vital information that is required for support on job sites.

Comparing the ratio of operating and non-operating hours helps to enhance efficiency. Effective management of maintenance programs helps to maximise availability. Running costs

can also be managed by analysing the fuel consumption. The location and movements of each machine are clearly displayed for essential planning.

An automatic service report — ConSite — sends a monthly email summarising the information from Global e-Service for each machine. This includes: daily working hours and fuel consumption data; statistics on the operating mode ratio, plus a comparison for fuel consumption/efficiency, and emissions.

## Technical support

Each Hitachi service technician receives full technical training. This provides technicians access to the Hitachi's global experience and knowledge available within the Hitachi quality assurance departments and design centres. Technicians combine this global expertise with the local language and culture of the customer to provide the highest level of after-sales support.





Global e-Service

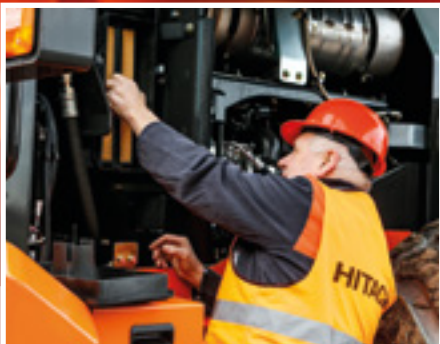

Technical support



Hitachi Parts

## Extended warranty and service contracts

Every new Hitachi ZW-6 model is covered by a full manufacturer's warranty. For extra protection — due to severe working conditions or to minimise equipment repair costs — Hitachi can offer a unique extended warranty and comprehensive service contracts. These can help to enhance ownership experience of each machine, reduce downtime and ensure higher resale values.

## Parts

Hitachi parts are available locally via Hitachi Branch network across Australia and New Zealand.

- Hitachi Genuine Parts allow machines to work longer with lower running and maintenance costs.
- Hitachi Genuine Parts are of proven quality and come with the manufacturer's warranty.

- Hitachi rebuilt components are available from Hitachi's in-house remanufacture centre and are offered with a standard warranty.

- Parts can be ordered via Hitachi Online Parts, local branches or Hitachi's 24/7 support centre.

Whatever the choice, the renowned quality of Hitachi construction machinery is assured.



Compact wheel loaders



ZAXIS excavators



EH dump trucks



“ We develop construction machinery that contributes to the creation of affluent and comfortable societies ”

Koutarou Hirano, HCM President

## BUILDING A BETTER FUTURE

Established in 1910, Hitachi, Ltd. was built upon a founding philosophy of making a positive contribution to society through technology. This is still the inspiration behind the Hitachi group's reliable solutions that answer today's challenges and help to create a better world.

Hitachi, Ltd. is now one of the world's largest corporations, with a vast range of innovative products and services. These have been created to challenge convention, improve social infrastructure and contribute to a sustainable society.

Hitachi Construction Machinery Co., Ltd. (HCM) was founded in 1970 as a subsidiary of Hitachi, Ltd. and has become one of the world's largest construction equipment suppliers. A pioneer in producing hydraulic excavators, HCM also manufactures wheel loaders, rigid dump trucks, crawler cranes and special application machines at state-of-the-art facilities across the globe.

Incorporating advanced technology, Hitachi construction machinery has a reputation for the highest quality standards. Suitable for a wide range of industries, it is always

hard at work around the world – helping to create infrastructure for a safe and comfortable way of living, developing natural resources and supporting disaster relief efforts.

Hitachi ZW wheel loaders are renowned for being reliable, durable and versatile – capable of delivering the highest levels of productivity under the most challenging of conditions. They are designed to provide owners with a reduced total cost of ownership, and operators with the ultimate level of comfort and safety.



EX ultra-large excavators

# SPECIFICATIONS

## ENGINE

Model .....	CUMMINS QSL9
Type .....	4-cycle water-cooled, direct injection
Aspiration .....	Turbocharger and intercooled
Aftertreatment .....	DOC and SCR system
No. of cylinders .....	6
Maximum power	
ISO 14396.....	232 kW (311 hp) at 1 600 min <sup>-1</sup> (rpm)
ISO 9249, net .....	225 kW (302 hp) at 1 600 min <sup>-1</sup> (rpm)
Rated power	
ISO 14396.....	212 kW (284 hp) at 2 000 min <sup>-1</sup> (rpm)
ISO 9249, net .....	203 kW (272 hp) at 2 000 min <sup>-1</sup> (rpm)
Maximum torque, gross ...	1 451 Nm at 1 400 min <sup>-1</sup> (rpm)
Bore and stroke .....	114 mm X 145 mm
Piston displacement .....	8.9 L
Batteries .....	2 x 12 V
Air cleaner .....	Two element dry type with restriction indicator
Emission .....	Complies with EU stage IV and US EPA Tier 4 Final

Engine output  
(kW)

Engine torque  
(Nm)

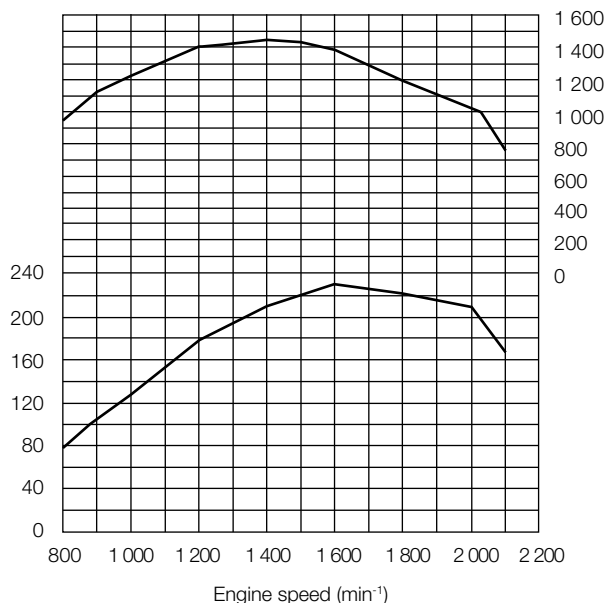

## POWER TRAIN

Transmission .....	Torque converter, countershaft type powershift with computer-controlled automatic shift and manual shift features included
Torque converter .....	Three element, single stage, single phase with lock-up clutch
Main clutch .....	Wet hydraulic, multi-disc type
Cooling method .....	Forced circulation type
Travel speed* Forward / Reverse	
1st .....	6.5 [6.8] / 6.5 [6.8] km/h
2nd .....	11.2 (11.3) [11.8 (11.7)] / 11.2 (11.3) [11.8 (11.7)] km/h
3rd .....	21.9 (22.1) [21.9 (22.1)] / 21.9 (22.1) [21.9 (22.1)] km/h
4th .....	36.0 (36.0) [36.0 (36.0)] / 36.0 (36.0) [36.0 (36.0)] km/h

\*With 26.5R25(L3) tires

( ) : Data at Lock-up clutch ON

[ ] : Data at Power mode

## AXLE AND FINAL DRIVE

Drive system .....	Four-wheel drive system
Front & rear axle .....	Semi-floating
Front .....	Fixed to the front frame
Rear .....	Trunnion support
Reduction and differential gear .....	Two stage reduction with torque proportioning differential (std) / limited slip differential (optional)
Oscillation angle .....	Total 24° (+12°, -12°)
Final drives .....	Heavy-duty planetary, mounted inboard

## BRAKES

Service brakes .....	Inboard mounted fully hydraulic 4 wheel wet disc brake. Front & rear independent brake circuit
Parking brake .....	Spring applied, hydraulically released, located in transmission

## STEERING SYSTEM

Type .....	Articulated frame steering
Steering angle .....	Each direction 37° ; total 74°
Cylinders .....	Double-acting piston type
No. x Bore x Stroke .....	2 x 90 mm x 450 mm

## HYDRAULIC SYSTEM

Arm and bucket are controlled by multifunction lever  
 Arm controls .....

Four position valve ; Raise, hold, lower, float
---

Bucket controls with automatic bucket return-to-dig control .....

Three position valve ; Roll back, hold, dump
--

Main pump (Serve as steering pump)

.....	Variable piston type
Maximum flow .....	300 L/min at 2 000 min <sup>-1</sup> (rpm)
Maximum pressure ...	31.4 MPa

Fan pump

.....	Gear type
Maximum flow .....	85 L/min at 2 000 min <sup>-1</sup> (rpm)
Maximum pressure ...	16.5 MPa

Hydraulic cylinders

Type .....	Double acting type
No. x Bore x Stroke ...	Arm : 2 x 150 mm x 930 mm Bucket : 1 x 190 mm x 507 mm

Filters .....

Full-flow 15 micron return filter in reservoir
--

Hydraulic cycle times

Lift arm raise .....	6.4 s (6.3 s)
Lift arm lower .....	4.4 s (4.4 s)
Bucket dump .....	1.2 s (1.2 s)
Total .....	12.0 s (11.9 s)

( ) : Data at Power Mode

## SERVICE REFILL CAPACITIES

Fuel tank .....	375 L
Engine coolant .....	47 L
Engine oil .....	24 L
Torque convertor & transmission .....	51 L
Front axle differential & wheel hubs .....	60 L
Rear axle differential & wheel hubs .....	60 L
Hydraulic oil tank .....	137 L
DEF/AdBlue® tank .....	35 L

## DIMENSIONS & SPECIFICATIONS

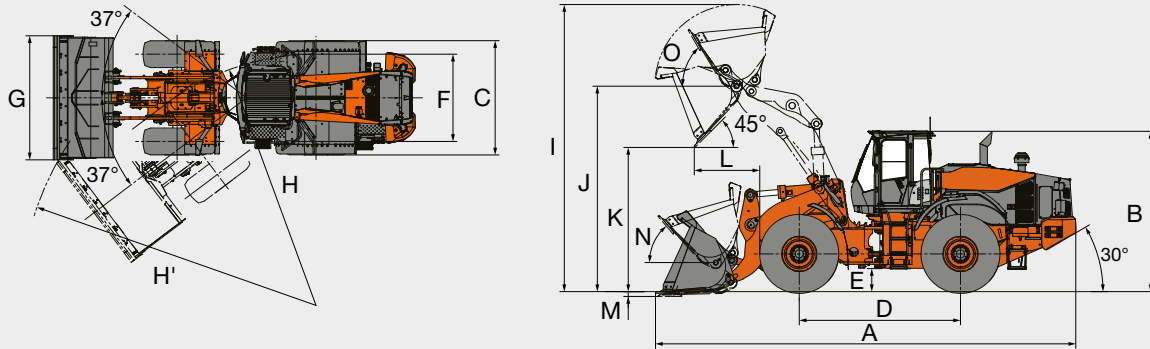

Bucket type			Standard arm					High lift arm
			General purpose			Rock bucket		Light material
			Straight edge			Straight edge		Straight edge
			Bolt-on cutting edge	Bolt-on cutting edge	Bolt-on cutting edge	Bolt-on teeth	Bolt-on cutting edge	
Bucket capacity	ISO heaped	m <sup>3</sup>	5.0	4.8	4.6	3.9	4.6	
	ISO struck	m <sup>3</sup>	4.4	4.2	4.0	3.3	4.0	
A Overall length		mm	9 235	9 255	9 155	9 295	9 590	
B Overall height		mm			3 530			
C Width over tires		mm			2 930			
D Wheel base		mm			3 550			
E Ground clearance		mm			505			
F Tread		mm			2 230			
G Bucket width		mm	3 170	3 170	3 170	3 185	3 170	
H Turning radius (Centerline of outside tire)		mm			6 420			
H' Loader clearance radius, bucket in carry position		mm	7 555	7 535	7 535	7 580	7 715	
I Overall operating height		mm	6 285	6 320	6 200	5 980	6 645	
J Height to bucket hinge pin, fully raised		mm			4 525		4 970	
K Dumping clearance 45 degree, full height		mm	3 190	3 175	3 245	3 125	3 690	
L Reach, 45 degree dump, full height		mm	1 415	1 440	1 360	1 440	1 365	
M Digging depth (Horizontal digging angle)		deg	105	105	105	135	105	
N Max. roll back at carry position		deg			50		47	
O Roll back angle at full height		deg			60			
Static tipping load *	Straight	kg	20 160	20 670	20 340	20 770	17 380	
	Full 37 degree turn	kg	17 590	18 040	17 750	18 030	15 170	
Breakout force		kN	203	200	215	232	215	
		kgf	20 780	20 480	21 970	23 680	22 010	
Operating weight *		kg	27 340	26 740	27 210	26 820	27 050	

Note: All dimensions, weight and performance data based on ISO 6746-1:1987, ISO 7131:2009 and ISO 7546:1983

\*: Static tipping load and operating weight marked with\* include 26.5R25(L3) tires (No ballast) with lubricants, full fuel tank and operator. Machine stability and operating weight depend on counterweight, tire size and other attachments.

## WEIGHT CHANGE

Option item	Operating weight (kg)	Tipping load (kg)		Overall width (mm) (outside tire)	Overall height (mm)	Overall length (mm)
		Straight	37 degree turn			
Tire	26.5R25(L3) VMT	± 0	± 0	± 0	± 0	± 0
	26.5R25(L3) XHA2	± 0	± 0	± 0	± 0	± 0
	26.5R25(L5) VSDL	+ 660	+ 480	+ 420	+ 15	+ 35

## BUCKET SELECTION GUIDE

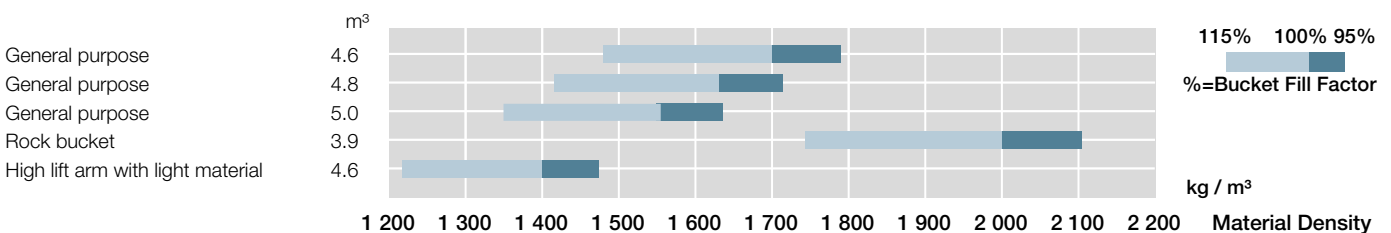

# EQUIPMENT

● ..... Standard equipment

○ ..... Optional equipment

## OPERATOR'S STATION

Adjustable steering column with POP-UP	●
Radio	
AM/FM radio with Bluetooth	●
Ashtray, cigar lighter	●
Auto control air conditioner *	
with single intake filter	○
with double intake filter	●
Coat hook	●
Front/Rear defroster	●
Glove compartment	●
Rear view camera & monitor	●
Rear view mirrors	
Inside (2)	●
Outside (2)	●
Outside (Heated, 2)	●
Retractable seat belt, 50mm	●
Retractable seat belt, 75mm	○
ROPS (ISO3471), FOPS (ISO3449): multi-plane isolation mounted for noise, vibration reduction	●
Rubber floor mat	●
Seat	
Air suspension seat (heavy duty) with headrest and heater: fabric, high back, adjustable for damper, inclination of the seat, seat depth, weight-height, fore-aft position, reclining angle, armrest angle, headrest height and angle, lumbar support	●
Steering system	
Wheel steering	●
Joystick steering (with wheel steering)	●
Storage	
Cup holder	●
Digital audio player holder	●
Document holder	●
Hot & cool box	●
Seatback pocket	●
Sun shade film on front windshield	○
Sun visor	●
Textured steering wheel with spinner knob	●
Tinted safety glass	
Front windshield: laminated	●
Others: tempered	●
Windshield washers for front and rear	●
Windshield wipers for front and rear	●

## ELECTRICAL SYSTEM

Backup alarm	●
Batteries	
Standard batteries (108Ah-765CCA)	●
Large capacity batteries (140Ah-930CCA)	●
Battery disconnect switch	●
12V power outlet	○

## LIGHTS

Bracket & switch for rotating beacon	○
Brake & tail lights LED	●
Clearance lights	●
Headlights	●
Turn signals with hazard switch	●
Work lights	
Front lights on cab (2) LED	●
Rear lights on rear grille side cover (2) LED	●
Additional front lights on cab (2) LED	●
Rear lights on cab (2) LED	●

## POWER TRAIN

Automatic transmission with load sensing system	●
Axle oil cooler	●
Clutch cut position switch	●
Differential	
TPD (Torque Proportioning Differential, front and rear)	●
LSD (Limited Slip Differential, front and rear)	○
DSS (Down Shift Switch)	●
Forward/Reverse lever	●
Forward/Reverse selector switch	●
Lock-up clutch (torque converter)	●
Power mode switch	●
Quick power switch	●
Travel mode selector (Auto1-Auto2)	●

## ENGINE

Air filter double elements	●
Automatic reversible cooling fan with heat sensing	●
Cartridge-type engine oil filter	●
Cartridge-type fuel pre-filter (with water separator function)	●
Cartridge-type fuel main filter	●
Coolant reservoir sight gauge	●
DEF/AdBlue® tank with ISO magnet adapter	●
Engine auto shut-down control system	○
Engine oil remote drain	●
Fan guard	●
Pre-cleaner (Sy-Klone)	●
Radiator (standard fin pitch radiator)	●

\* Contains fluorinated greenhouse gases, Refrigerant type: HFC-134a, GWP: 1430, Amount: 0.90 kg, CO<sub>2</sub>e: 1.29 ton.





## MONITORING SYSTEM

Gauge: coolant temperature, fuel	●
Indicator lights: clearance lights, control lever lock, fuel level, high beam, parking brake, preheat, turn signals, work lights	●
Indicator on multifunction monitor: air conditioner display, auto shut-down indicator, clock, clutch cut off indicator, DEF alarm indicator, DEF level gauge, dual lift arm auto leveler indicator, ECO indicator, fan reverse indicator, F-N-R/ shift position indicator, forward/reverse selector switch indicator, hold display, hour meter, joystick steering indicator (optional), odometer, power mode indicator, ride control indicator, seat belt indicator, speedometer, tachometer, transmission auto-shifting indicator, transmission oil temperature	●
Warning lights: air filter restriction, brake oil low pressure, communication system error, discharge warning, engine oil low pressure, engine warning, hydraulic oil level, low steering oil pressure, overheat, transmission warning	●

## BRAKE SYSTEM

Front & rear independent brake circuit	●
Inboard mounted fully hydraulic 4 wheel wet disc	●
Spring-applied/Hydraulic-released parking brake	●

## HYDRAULIC SYSTEM

Bucket auto leveler (Automatic return to dig control)	●
Control lever	
for 2 spools control valve	
Multifunction lever (MF lever)	 ○
2 levers	 ○
for 3 spools control valve	
MF lever & AUX lever for 3rd function	 ●
2 levers & AUX lever for 3rd function - Inside layout pattern (3rd - bucket - liftarm)	 ○
Control lever lock switch	●
Dual lift arm auto leveler	●
Hydraulic filters	●
Lift arm float system	●
Ride control system (OFF-AUTO type)	●

## TIRES

26.5R25(L3) XHA2	○
26.5R25(L5) VSDL	○
26.5R25(L3) VMT	●

## MISCELLANEOUS

Articulation lock bar	●
Belly guard (Bolt on type)	●
Bucket cylinder guard	●
Counterweight, built-in	●
Drawbar with locking plate	●
Emergency steering	●
Fenders	
for 26.5R25 (Front & full covered rear fenders with mud flaps)	●
Global e-Service	●
Lift arm	
Standard lift arm	●
High lift arm	○
Lift & tie down hooks	●
On board information controller	●
Pilfer proof	
Battery cover with locking bracket	●
Lockable engine cover	●
Lockable fuel refilling cap	●
Rear view camera monitor (high mount separated type)	●
Standard tool kit	●

Prior to operating this machine, including satellite communication system, in a country other than a country of its intended use, it may be necessary to make modifications to it so that it complies with the local regulatory standards (including safety standards) and legal requirements of that particular country. Please do not export or operate this machine outside the country of its intended use until such compliance has been confirmed. Please contact your Hitachi dealer in case of questions about compliance.

**CablePrice Pty Ltd**

[www.cableprice.co.nz](http://www.cableprice.co.nz)

**Hitachi Construction Machinery Australia**

[www.hitachicm.com.au](http://www.hitachicm.com.au)

These specifications are subject to change without notice.

Illustrations and photos show the standard models, and may or may not include optional equipment, accessories, and all standard equipment with some differences in color and features. Before use, read and understand the Operator's Manual for proper operation.

KL-EN137AU

Printed in Australia